

D0280270 - Single Towel Rail

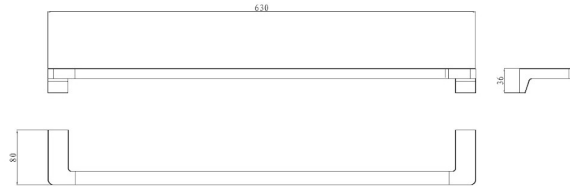

D0280270DH - Single Towel Rail (Black)

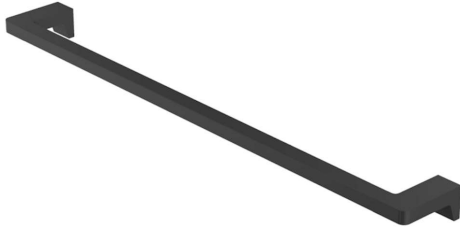
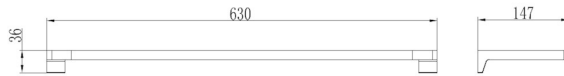

D0280272 - Double Towel Rail (650mm)

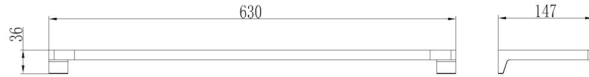
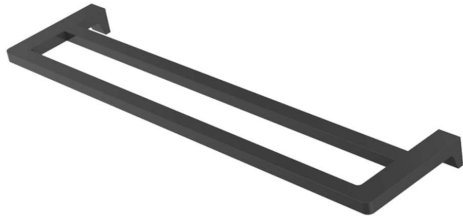

D0280272DH - Double Towel Rail (650mm Black)

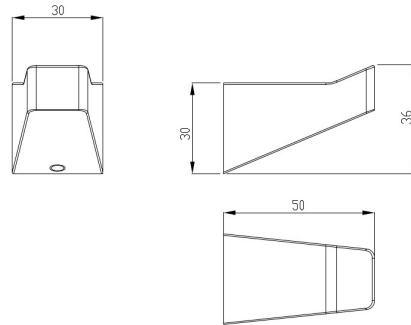

D0380270 - Robe Hook

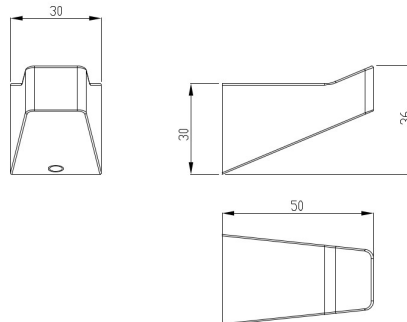
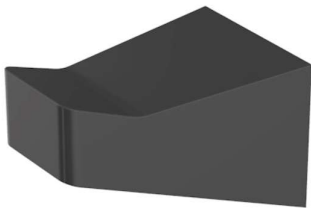

D0380270DH - Robe Hook (Black)

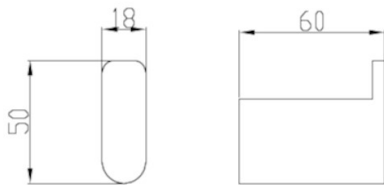

D56001A - Robe Hook

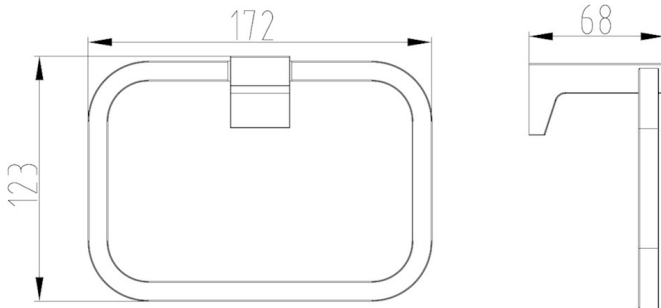

D0480271 - Towel Ring

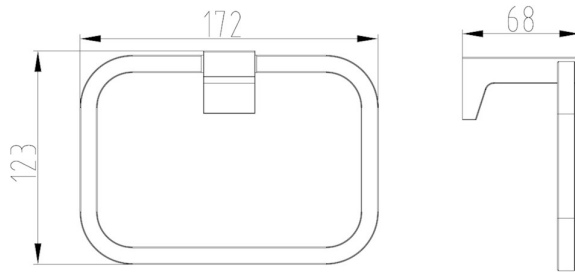

D0480271DH - Towel Ring (Black)

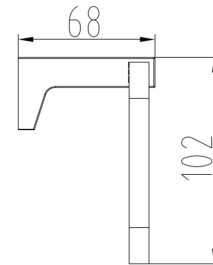
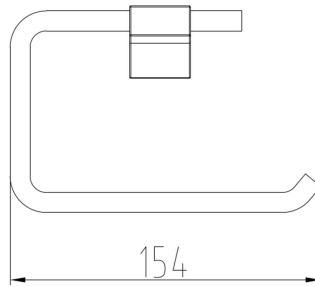

D0680270 - Tissue Holder

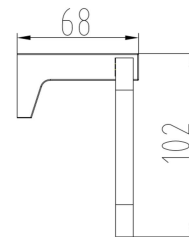
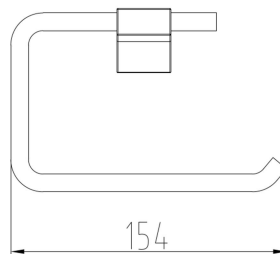
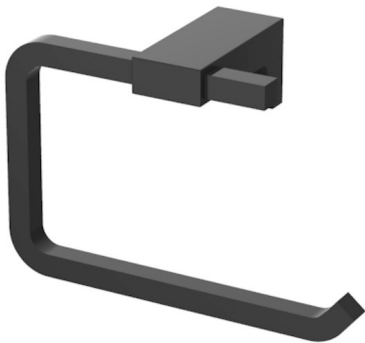

D0680270DH - Tissue Holder (Black)

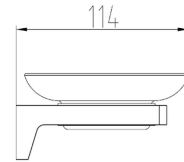
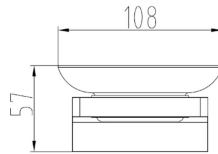

D0780270 - Soap Holder

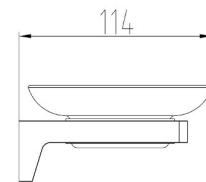
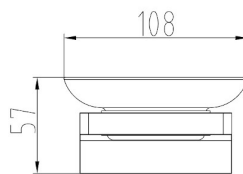
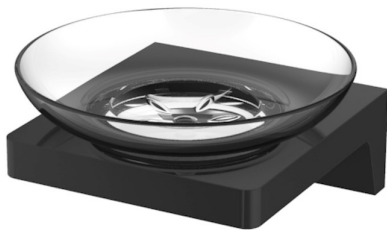

D0780270DH - Soap Holder (Black)



HALE SERIES

Accessories

Our Hale range features the pairing of a classic rounded body with a distinctly squared handles and spouts. The Hale bathroom accessories are certain to provide interest to any modern bathroom or laundry.

Finishes:	Chrome/ Black
Material:	Zinc
Fixing:	Wall materials vary. The accessory fixing kit supplied is suited for solid wall fixing. For timber framed walls, please ensure the accessory is fixed to a stud/noggin behind the wall. Where stud/noggin is not available, please use suitable hollow wall fixing.
Cleaning Recommendations:	We recommend the use of soapy water or approved cleaners. This product should not be cleaned with abrasive materials. Damage caused by any improper treatment is not covered by the product warranty. Refer to Warranty Condition.
Warranty:	7 Year Replacement Product or Parts 1 Year Finish (Chrome finish covered under standard Product or Parts Warranty) <i>Please refer to Warranty Guide for full terms & conditions</i>

While we aim to ensure the specifications shown are correct at time of printing, Summer reserves the right to make modifications without prior notice. Always use the physical product measurements for mark-ups and roughing-in as the line drawing shown may differ from the actual product over time. All measurements are shown in millimetres. Colours may vary from image shown.