

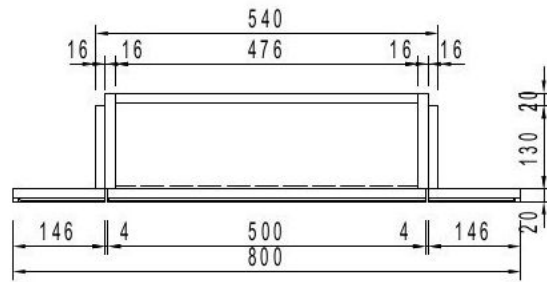

Mirage Round Mirror Shaving Cabinet 800mm

NGB_SCR_800

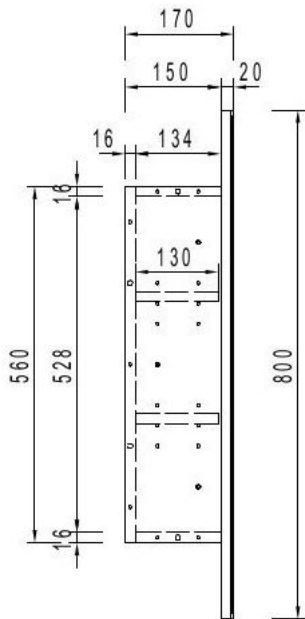
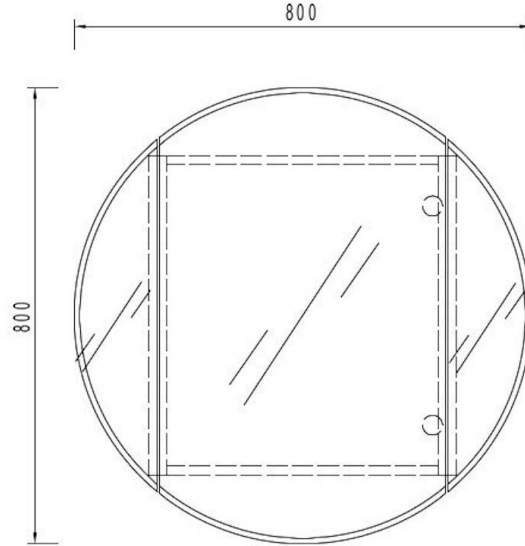

The Mirage Round Mirror Shaving Cabinet is available in both a frameless and black trim. This cabinet can be completely recessed into your wall for a seamless finish, or semi-recessed to access the built in LED light trough.

Note: Recessed shaving cabinets require professional installation – please contact your builder as this may require planning prior to installation of plasterboards.

INSTALLATION GUIDE

Mirage Round Shaving Cabinet 800mm

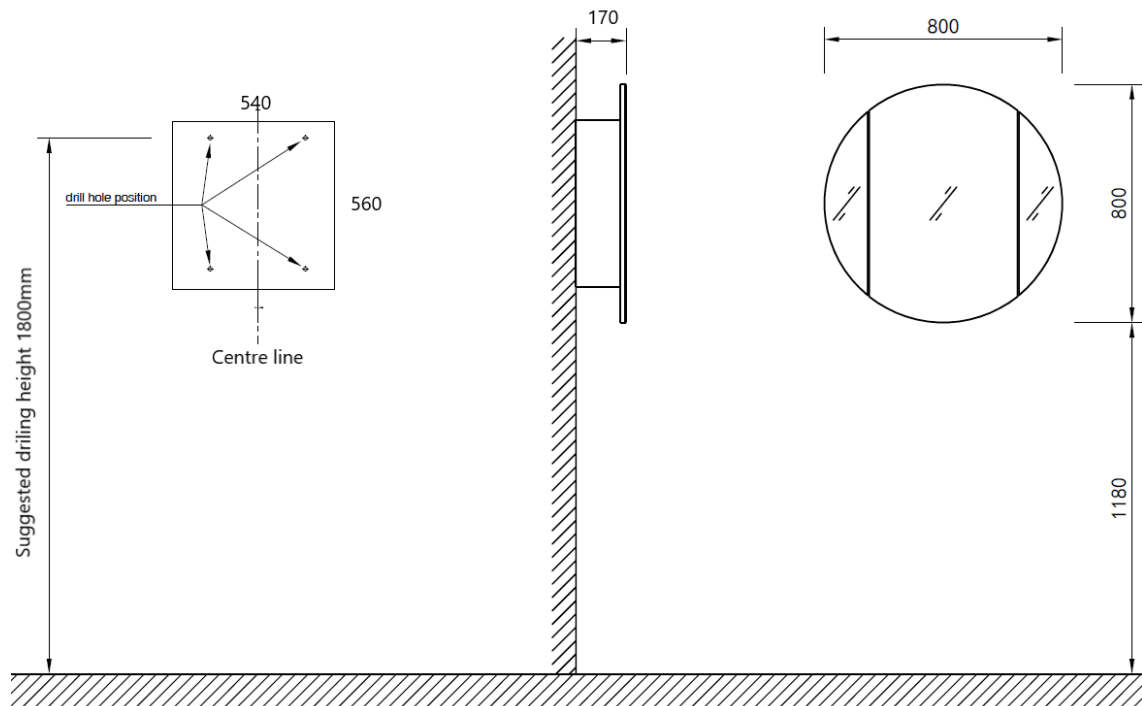

The guide provides a suggested installation height for the Mirage cabinet however please ensure you **adjust according to the height of the user and space**. The diagram above demonstrates how to install the 800mm Mirage Shaving Cabinet at total height (top of mirror) of 1980mm.

PRIOR TO INSTALLATION

1. Ensure that the cabinet is being installed onto a load-bearing wall
2. Check that there are no electrical wires or water lines behind wall prior to drilling

INSTALLATION

1. Confirm desired height of mirror (consider user height, vanity height and tapware height)
2. Mark out drill hole positions on wall using the pre drilled holes in the cabinet and dimensional drawing as a guide, ensuring it is levelled and centred
3. Use an impact drill to drill into marked holes on wall
4. Push expansion rubber particle into these holes
5. Secure the cabinet with self-tapping screw, ensuring cabinet is levelled
6. Optional: cover the screw with self-adhesive screw cover cap
7. Attach side mirror using dowel provided and secure to the cabinet from behind using L brackets supplied (2 each side)
8. Centre mirror door can be adjusted at the hinge to level (if required)

LED CHANNEL & COVER INSTALLATION

1. Please note the LED channel and cover is not fixed to the cabinet by design. It allows for ease of installation of LED light. See picture below.
2. Once the LED light is installed (or if not installing), LED channel and cover can be fixed to the light trough by applying a bead of a household adhesive like Selleys All Purpose Glue Adhesive or super glue or similar.
3. Please consult your electrician regarding installation of LED driver and light strip.
4. If you have purchased the Havit LED light add on option, please refer to our website www.avahome.com.au for downloadable data sheet and installation guide. Please note Havit product warranty requires that their products be installed by a licensed electrician.



View from underneath cabinetry

(Cannot be seen when standing or in use)